

## 3R WireEDM EconoRuler

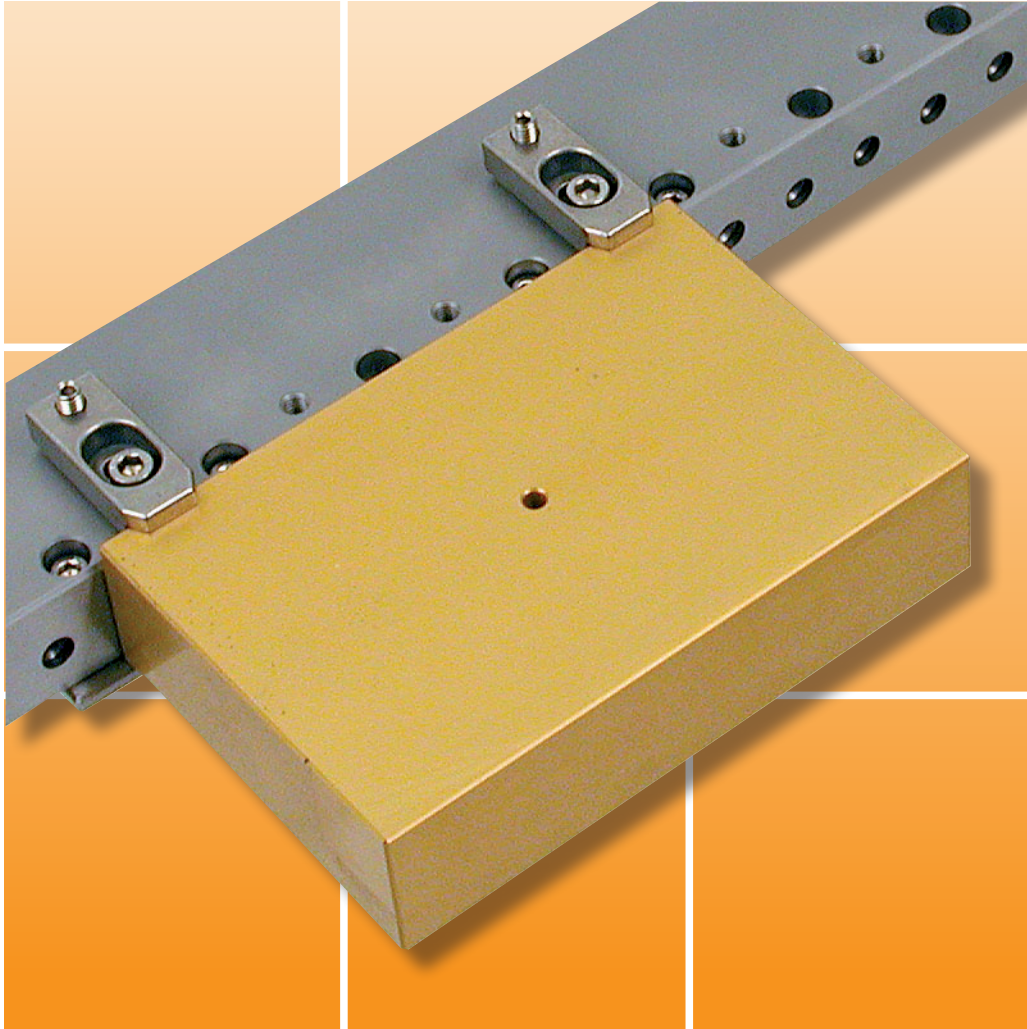

## The ruler kits from System 3R

have been developed for clamping medium-sized and large work pieces in machines with a parallel or U-shaped machine table, as well as for machines with a frame table.

A comprehensive range of accessories enables a wide variety of applications.

### Advantages

- ▶ Robust design
- ▶ Flexible – use the rulers in pair or alone, depending on your set-up
- ▶ Highest cutting rates – locate the work piece on the machine zero line
- ▶ Collision free set-up – use spacers under the rulers
- ▶ Fitting wide range of machine tables
- ▶ Enables usage of various work piece sizes

### Ruler, 3R-209-610

- ▶ Dimensions: 610x30x60 mm
- ▶ Clamping range: 300–580 mm
- ▶ Material: Ramax
- ▶ Includes two clamp/support sets, mounting screws, and spacers for collision-free setup

### Ruler kits

- ▶ 3R-209-610.1 – Single ruler
- ▶ 3R-209-610.2 – Two rulers and two adjustable clamps
- ▶ 3R-209-610.3 – Single ruler and two adjustable supports

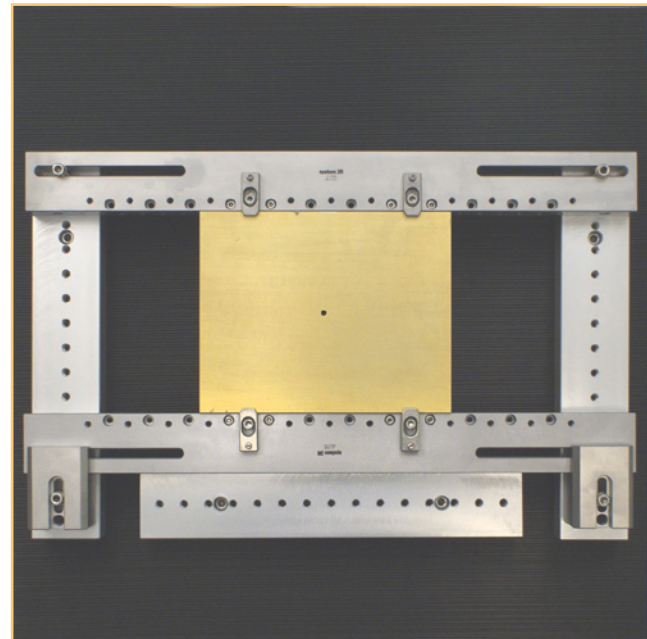
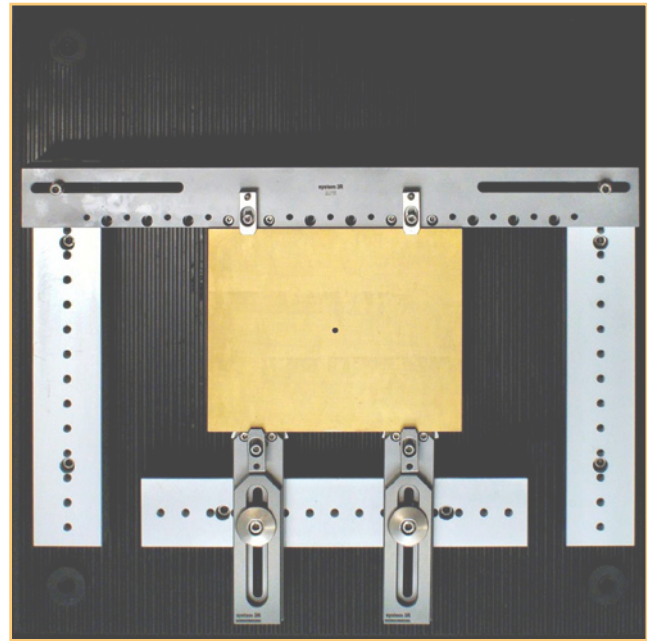

### Ruler

3R-209-610

Universal ruler for mounting directly on the machine table.  
Fits machine tables with hole pitch 300-580 mm.

- Length 610 mm.

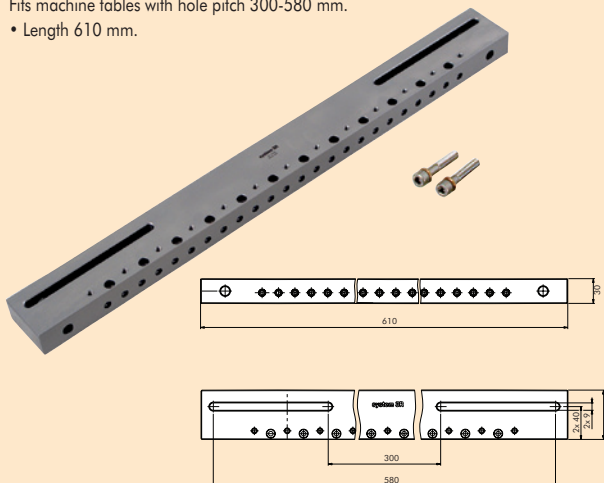

### Sliding support

3R-261.1

- For mounting directly on the machine table.
- Adjustable length 35-135 mm
- Recommended maximum workpiece weight 20 kg
- Includes 5 mm spacer for collision free set-up
- Weight 1.5 kg

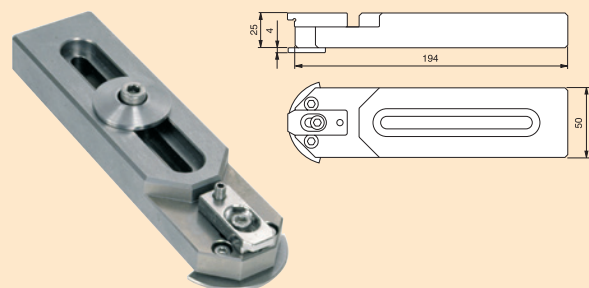

## Ruler kits

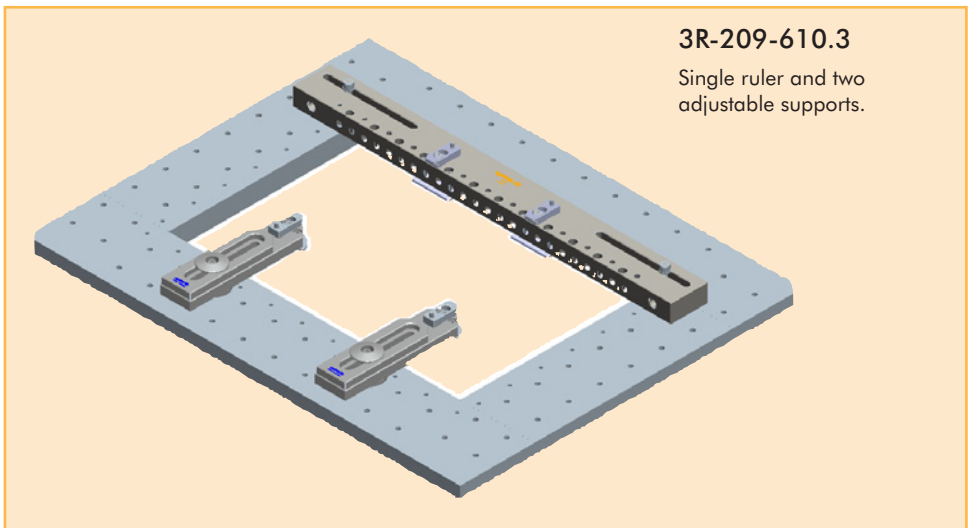
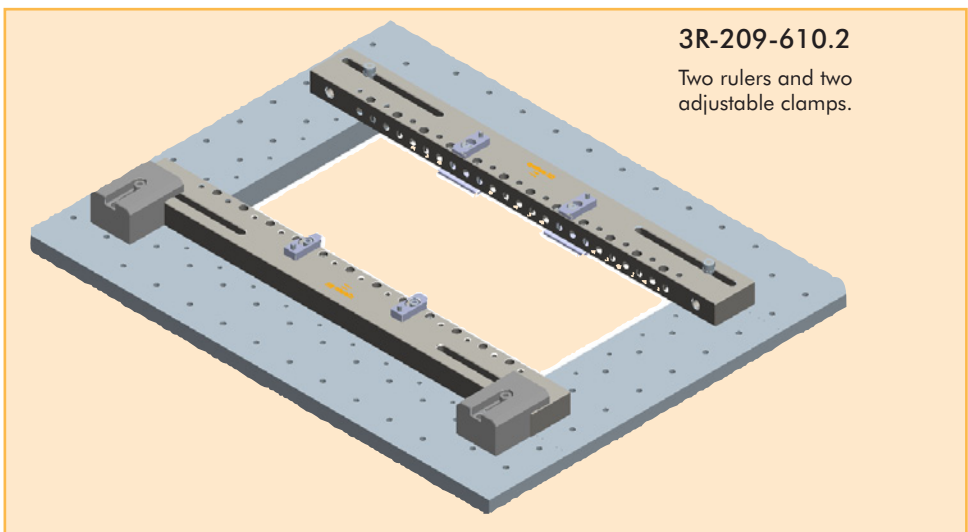
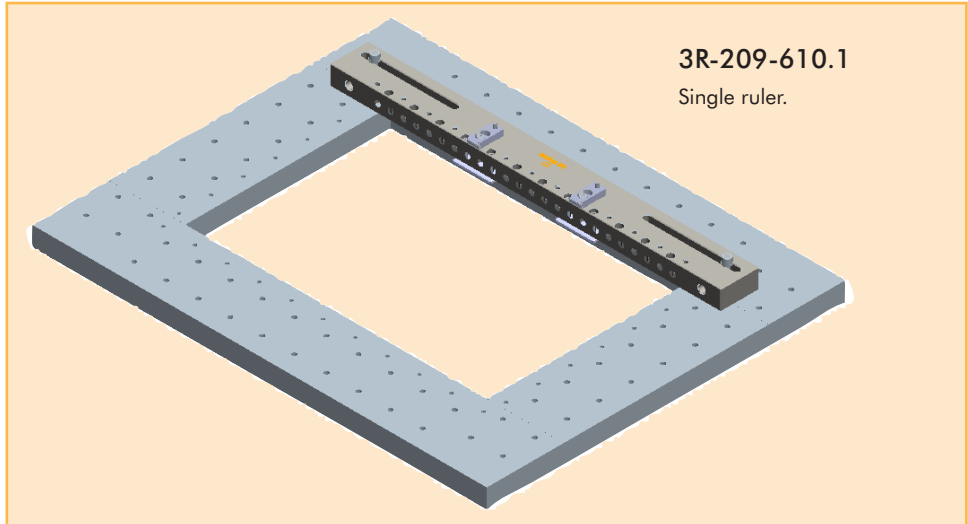

## Accessories



## System 3R International AB

Sorterargatan 1, SE-162 50 VÄLLINGBY

tel +46-08 620 20 00, fax +46-08 759 52 34, e-mail: [info@system3r.com](mailto:info@system3r.com), [www.system3r.com](http://www.system3r.com)

### ASIA

*Far East, China & India*  
**System 3R Far East Pte.Ltd.**  
6 Harper Road  
Leong Huat Building, 01-01  
SINGAPORE SG-369 674  
tel +65-6289 4811  
fax +65-6289 3011  
e-mail: [info.sg@system3r.com](mailto:info.sg@system3r.com)

**Shanghai Contact Office**  
tel +86-21 6432 7927  
fax +86-21 6432 7928  
e-mail: [info.cn@system3r.com](mailto:info.cn@system3r.com)

**Beijing Contact Office**  
tel +86-10 8225 1632  
fax +86-10 8225 1635

**Guangdong Contact Office**  
tel +86-769 8162 0628  
fax +86-769 8162 0638

**Malaysia Contact Office**  
tel +60-03 7877 4785  
fax +60-03 7877 5948

**Taiwan Regional Office**  
tel +886-02 2278 3126  
fax +886-02 2278 3108

**Thailand Contact Office**  
tel / fax +66-2 6422 764

*Japan & Korea*  
**System 3R Japan CO., Ltd.**  
Kaki Building  
2-5-22, Suido, Bunkyo-ku  
TOKYO JP-112-0005  
tel +81-03 5840-7383  
fax +81-03 5840-8723  
e-mail: [info.jp@system3r.com](mailto:info.jp@system3r.com)

**Nagoya Regional Office**  
tel +81-052 774 6250  
fax +81-052 774 6285

**Osaka Regional Office**  
tel +81-06 6396 1500  
fax +81-06 6396 2855

### EUROPE

**System 3R Europe GmbH**  
Wasserweg 19  
DE-64521, GROSS-GERAU  
tel +49 61 52 80 02 0  
fax +49 61 52 80 02 35  
e-mail: [info.eu@system3r.com](mailto:info.eu@system3r.com)

*Czech Republic & Slovakia*  
**System 3R Czech**  
Tiskarska 10/257  
CZ-108 28 PRAHA 10  
tel +420 234 054 224  
fax +420 234 054 225  
e-mail: [info@system3r.cz](mailto:info@system3r.cz)

*France & Portugal*  
**System 3R France**  
56 Boulevard de Courcierin  
Les Espaces Multiservices 15  
F-77183 CROISSY BEAUBURG  
tel +33-01 60 95 90 80  
fax +33-01 60 37 88 16  
e-mail: [info.fr@system3r.com](mailto:info.fr@system3r.com)

*Germany & BeNeLux*  
**System 3R Deutschland**  
Wasserweg 19  
DE-64521, GROSS-GERAU  
tel +49 61 52 80 02 0  
fax +49 61 52 80 02 35  
e-mail: [info.de@system3r.com](mailto:info.de@system3r.com)

*Italy & Spain*  
**System 3R Italia**  
Via Ponchielli, 2/4  
IT-20063 CERNUSCO SUL NAVIGLIO (MI)  
tel +39 02 92 38 821  
fax +39 02 92 11 23 19  
e-mail: [info.it@system3r.com](mailto:info.it@system3r.com)

*Scandinavia*  
**System 3R Nordic**  
Sorterargatan 1  
SE-162 50 VÄLLINGBY  
tel +46-08 620 20 00  
fax +46-08 38 81 84  
e-mail: [info.no@system3r.com](mailto:info.no@system3r.com)

**Järfälla Hårdverkstad**  
Elektronikhöjden 8  
SE-175 43 JÄRFÄLLA  
tel +46-08 580 125 50  
fax +46-08 580 126 55  
e-mail: [info@jhv.se](mailto:info@jhv.se)

*Switzerland & Austria*  
**System 3R Schweiz AG**  
Wilerstrasse 98  
CH-9230 FLAWIL  
tel +41-071 394 13 50  
fax +41-071 394 13 60  
e-mail: [info.ch@system3r.com](mailto:info.ch@system3r.com)

*Turkey*  
**System 3R Türkiye**  
Abdi İpekçi Cad. Özel İdare İş Merk 150/209  
Bayrampasa 34030 İSTANBUL  
tel +90-212 613 8062-8063  
fax +90-212 613 8069  
e-mail: [info.tu@system3r.com](mailto:info.tu@system3r.com)

*United Kingdom*  
**System 3R UK**  
Paradise Way  
Walsgrave Triangle  
Coventry, West Midlands  
CV2 2ST, United Kingdom  
tel +44-02476 538653  
fax +44-02476 538695  
e-mail: [info.uk@system3r.com](mailto:info.uk@system3r.com)

### AMERICAS

**System 3R USA Inc.**  
Headquarters & Technical Center  
915 Busse Road  
ELK GROVE VILLAGE, US-IL 60007  
tel +1 847 439 4888  
fax +1 847 439 5099  
e-mail: [info.us@system3r.com](mailto:info.us@system3r.com)

*Canada & Eastern MI*  
tel +1 847 439 4888  
fax +1 847 439 5099  
e-mail: [info.us1@system3r.com](mailto:info.us1@system3r.com)

*AZ, CA, CO, ID, MT, NM, NV, OR, UT, WA, WY & Mexico*  
tel +1 847 439 4888  
fax +1 847 439 5099  
e-mail: [info.us2@system3r.com](mailto:info.us2@system3r.com)

*IA, MN, ND, NE, SD & WI*  
tel +1 847 439 4888  
fax +1 847 439 5099  
e-mail: [info.us3@system3r.com](mailto:info.us3@system3r.com)

*AR, IN, KY, OH & TN*  
tel +1 847 439 4888  
fax +1 847 439 5099  
e-mail: [info.us4@system3r.com](mailto:info.us4@system3r.com)

*AL, FL, GA, LA, MS, NC, SC & TX*  
tel +1 847 439 4888  
fax +1 847 439 5099  
e-mail: [info.us5@system3r.com](mailto:info.us5@system3r.com)

*IL, KS, MO, OK & Western MI*  
tel +1 847 439 4888  
fax +1 847 439 5099  
e-mail: [info.us6@system3r.com](mailto:info.us6@system3r.com)

*NJ, NY & PA*  
tel +1 847 439 4888  
fax +1 847 439 5099  
e-mail: [info.us7@system3r.com](mailto:info.us7@system3r.com)

*CT, DC, DE, MA, MD, ME, NH, RI, VA, VT & WV*  
tel +1 847 439 4888  
fax +1 847 439 5099  
e-mail: [info.us8@system3r.com](mailto:info.us8@system3r.com)

*Eastern WI*  
tel +1 847 439 4888  
fax +1 847 439 5099  
e-mail: [info.us9@system3r.com](mailto:info.us9@system3r.com)

For further information, see  
[www.system3r.com](http://www.system3r.com)